

4K Series - Single Stage Stainless Steel End-Suction Centrifugal Pumps Flanged

3450 RPM Models

4K111-4K253

1725 RPM Models

4K341-4K353

FEATURES

- 304SSL liquid-end construction offers corrosion resistance and increases operating life over typical cast iron models.
- Unique bulge formed components eliminates harsh radius and welds and provides greater efficiency and durability.
- Back pullout design permits easy repair of impeller and seal.
- High quality mechanical shaft seal and o-rings for a variety of standard, high temperature or chemical duty applications.
- Under casing foot mount and centerline discharge reduces misalignment and assures self-venting.
- Convenient ANSI 150# mounting flanges for secure, easy installation.
- Close coupled, motorized packages for compact and easy installation.

SPECIFICATIONS

	U.S. Measure
Flow Range13 to 380 GPM
Pressure Range4.3 to 124 PSI
10 to 285 Ft. Head
Max. Working Pressure230 PSI
Min. Inlet Pressure to PrimeFlooded
RPM1725 or 3450 RPM
Inlet Fitting	4K111-4K153, 4K341-4K353.....2.00" ANSI 4K161-4K251, 4K381-4K453.....2.50" ANSI
Discharge Fitting	4K111-4K153, 4K341-4K353.....1.25" ANSI 4K161-4K213, 4K381-4K413.....1.50" ANSI 4K221-4K253, 4K421-4K453.....2.00" ANSI
Horsepower Range	1725 RPM.....1 to 2 HP 3450 RPM.....3 to 15 HP
Motor Options	1725 RPM, TEFC, Class F 1.0 HP, 143 JM Frame.....200-230/460V, 3 PH 1.5 HP, 145 JM Frame.....200-230/460V, 3 PH 2.0 HP, 145 JM Frame.....200-230/460V, 3 PH 3450 RPM, TEFC, Class F 3.0 HP, 182 JM Frame.....208-230/460V, 3 PH 5.0 HP, 184 JM Frame.....208-230/460V, 3 PH 7.5 HP, 213 JM Frame.....208-230/460V, 3 PH 10.0 HP, 215 JM Frame.....208-230/460V, 3 PH 15.0 HP, 215 JM Frame.....208-230/460V, 3 PH
Cycle60 HZ
Max. Temperature*	Continuous.....160°F
Weight (Pump Only)	4K111, 4K161, 4K171.....23.0 Lbs. 4K121, 4K131, 4K181, 4K191, 4K221, 4K231, 4K381, 4K421.....31.0 Lbs. 4K141, 4K151, 4K201, 4K211, 4K241, 4K251, 4K341, 4K351, 4K401, 4K411, 4K441, 4K451.....43.0 Lbs.
Dimensions	Pump Only.....(see chart)

*Contact CAT PUMPS for applications above 160°F.

“Customer confidence is our greatest asset”

EXPLODED VIEW

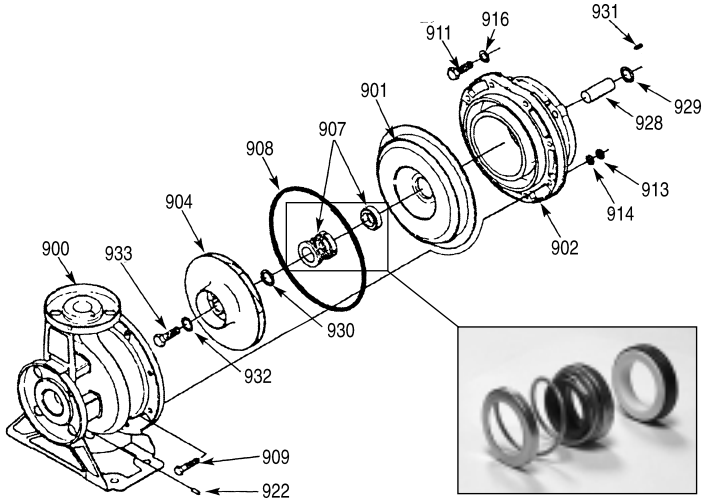

PARTS LIST

ITEM	P/N	MATL	DESCRIPTION	QTY
900	—	S	Casing	1
901	—	S	Cover, Casing	1
902	—	F	Bracket	1
904	899210	S	Impeller, 5.187" (4K111)	1
	899211	S	Impeller, 5.937" (4K121)	1
	899212	S	Impeller, 6.562" (4K131)	1
	899213	S	Impeller, 7.312" (4K141, 341)	1
	899214	S	Impeller, 7.875" (4K151, 351)	1
	899215	S	Impeller, 4.937" (4K161)	1
	899216	S	Impeller, 5.500" (4K171)	1
	899217	S	Impeller, 5.937" (4K181, 381)	1
	899218	S	Impeller, 6.562" (4K191)	1
	899219	S	Impeller, 7.187" (4K201, 401)	1
	899220	S	Impeller, 7.875" (4K211, 411)	1
	899221	S	Impeller, 5.187" (4K221, 421)	1
	899222	S	Impeller, 5.500" (4K231)	1
	899223	S	Impeller, 6.187" (4K241, 441)	1
	899224	S	Impeller, 6.562" (4K251, 451)	1
907	899091	NCC	Seal, Shaft Assy (Standard)	1
	899092	FCC	Seal, Shaft Assy (Mild Chemical)	1
	899093	HCC	Seal, Shaft Assy (High Temp)	1
908	899255	FPM	O-Ring, Case (4K111, 161, 171)	1
	899256	FPM	O-Ring, Case (4K121, 131, 181, 191, 221, 231, 381, 421)	1
	899257	FPM	O-Ring, Case (4K141, 151, 201, 211, 241, 251, 341, 351) (401, 411, 441, 451)	1
909	—	S	Screw, Hex Head (M8x30 or M10x35)	8/10
911	—	S	Screw, Hex Head (3/8-16x1" or 1/2-13x1-3/4")	4
913	—	S	Nut, Hex (M8 or M10)	8/10
914	—	S	Lockwasher, Toothed (M8 or M10)	8/10
916	—	S	Lockwasher, Toothed (3/8" or 1/2")	4
922	—	S	Plug, Casing	1
924	—	STL	Support, Motor (Not Shown)	2
928	899258	S	Sleeve, Shaft	1
929	899182	NY	Gasket, Shaft Sleeve (1" ID)	1
930	899181	NY	Gasket, Shaft Seal (7/8" ID)	1
931	899268	S	Key	1
932	899180	NY	Gasket, Impeller Bolt (13/16" ID)	1
933	—	S	Bolt, Impeller	1
934	899185	FPM	Gasket, Suction (1-1/4") (Not Shown)	1
935	899186	FPM	Gasket, Discharge (1-1/2") (Not Shown)	1

Italics are optional items.

MATERIAL CODES (Not Part of Part Number):

F=Cast Iron FCC=Carbon/Ceramic/FPM FPM=Fluorocarbon
 HCC=Carbon/Ni/Resist/FPM NY=Nylon NCC=Carbon/Ceramic/Buna
 S=304SS STL=Steel

DIMENSIONAL

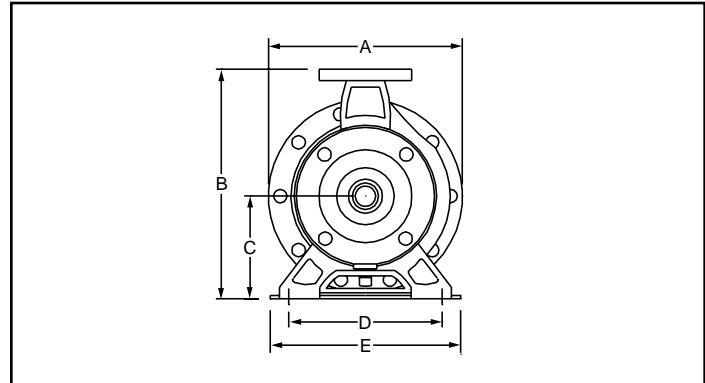
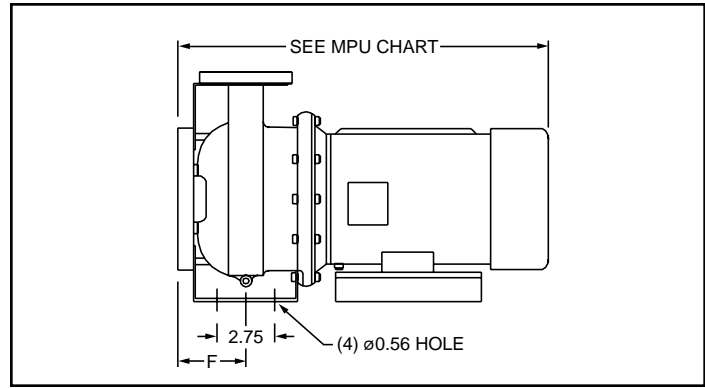

PUMP MODEL	A (in)	B (in)	C (in)	D (in)	E (in)	F (in)
4K111	8.38	9.94	4.44	5.50	7.50	3.13
4K121	10.00	11.50	5.19	7.50	9.44	3.13
4K131	10.00	11.50	5.19	7.50	9.44	3.13
4K141, 4K341	11.56	13.38	6.31	7.50	9.44	3.13
4K151, 4K351	11.56	13.38	6.31	7.50	9.44	3.13
4K161	8.38	9.94	4.44	6.31	8.25	3.13
4K171	8.38	9.94	4.44	6.31	8.25	3.13
4K181, 4K381	10.00	11.50	5.19	7.50	9.44	3.13
4K191	10.00	11.50	5.19	7.50	9.44	3.13
4K201, 4K401	11.56	13.38	6.31	8.38	10.44	3.94
4K211, 4K411	11.56	13.38	6.31	8.38	10.44	3.94
4K221, 4K421	10.00	11.50	5.19	7.50	9.44	3.94
4K231	10.00	11.50	5.19	7.50	9.44	3.94
4K241, 4K441	11.69	13.38	6.31	8.38	10.44	3.94
4K251, 4K451	11.69	13.38	6.31	8.38	10.44	3.94

MPU Model No.	Motor P/N	Motor wt (lbs)	MPU Lgth (in)	MPU wt (lbs)
4K341MT3	899145	34.00	18.78	77.00
4K351MT3	899146	38.00	18.78	81.00
4K381MT3	899145	34.00	18.53	65.00
4K401MT3	899146	38.00	19.53	81.00
4K411MT3	899147	44.00	19.53	87.00
4K421MT3	899145	34.00	19.28	65.00
4K441MT3	899146	38.00	19.53	81.00
4K451MT3	899147	44.00	19.53	87.00

MPU Model No.	Motor P/N	Motor wt (lbs)	MPU Lgth (in)	MPU wt (lbs)
4K111MT3	899140	73.00	20.54	96.00
4K121MT3	899141	92.00	20.79	123.00
4K131MT3	899141	92.00	20.79	123.00
4K141MT3	899142	118.00	22.25	161.00
4K151MT3	899143	140.00	23.75	183.00
4K161MT3	899141	92.00	20.54	115.00
4K171MT3	899141	92.00	20.54	115.00
4K181MT3	899142	118.00	22.00	149.00
4K191MT3	899143	140.00	23.75	171.00
4K201BT3	899144	159.00	24.44	202.00
4K211BT3	899144	159.00	24.44	202.00
4K221MT3	899142	118.00	22.75	149.00
4K231MT3	899143	140.00	24.50	171.00
4K241MT3	899143	140.00	24.50	183.00
4K251BT3	899144	159.00	24.44	202.00

PUMP CODES:

Last digit of Pump Kit is Seal Assembly type

- 1 = NCC Standard Seal Assy (Carbon/Ceramic/Buna) **Standard Service**
- 2 = FCC Alternate Seal Assy (Carbon/Ceramic/FPM) **Mild Chemical**
- 3 = HCC Alternate Seal Assy (Carbon/Ni-Resist/FPM) **High Temperature**

MPU CODES:

Last digit of MPU is Motor Phase and Voltage

- Single Phase Three Phase
- 0 = 115/208-230V 3 = 208-230/460V
- 1 = 115/230V 4 = 230/460V
- 2 = 230V 5 = 575V
- 6 = 380V

SELECTION CHART - 1725 RPM

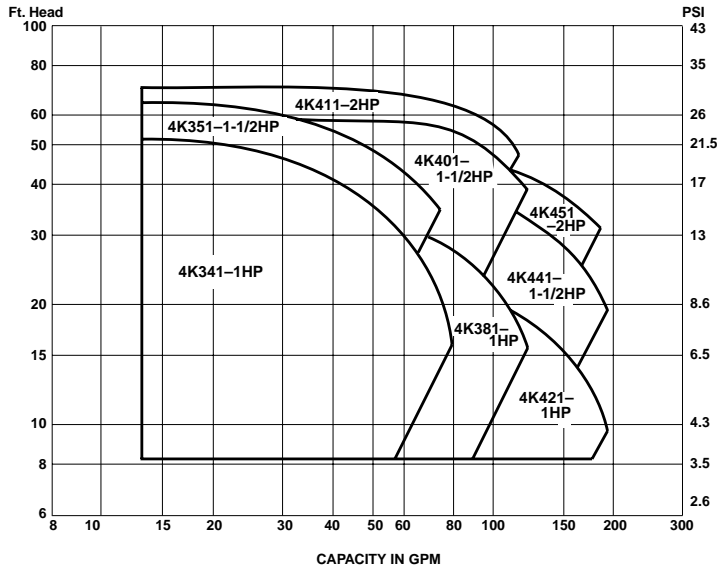

All calculations based upon water @ Spec. Gravity of 1.00

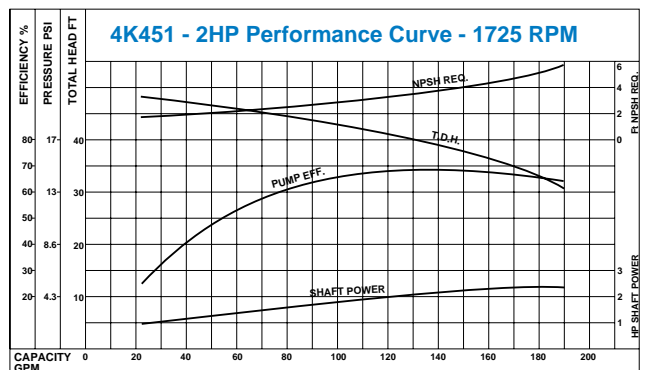
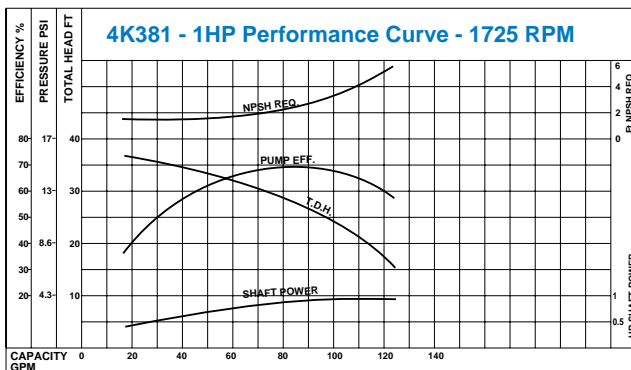
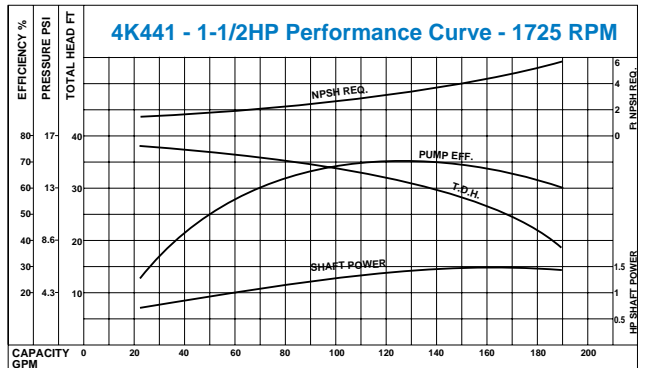
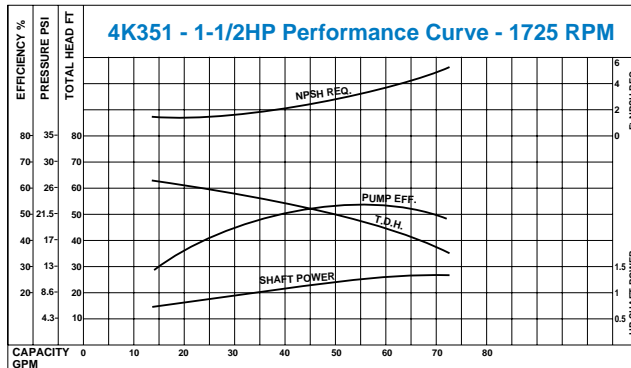
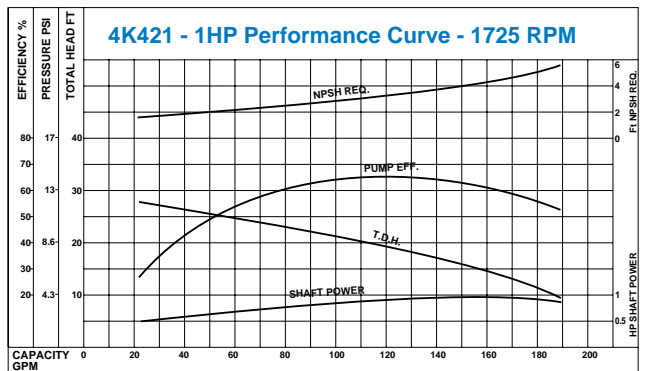
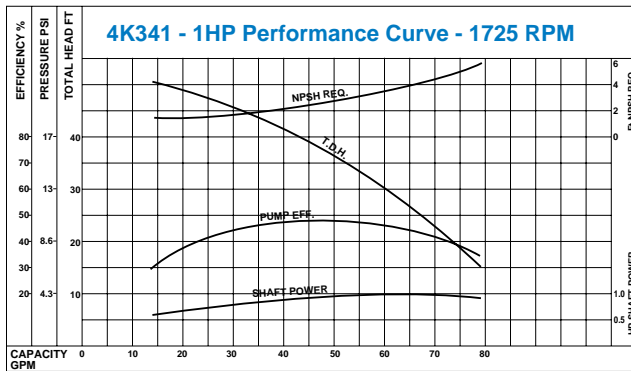
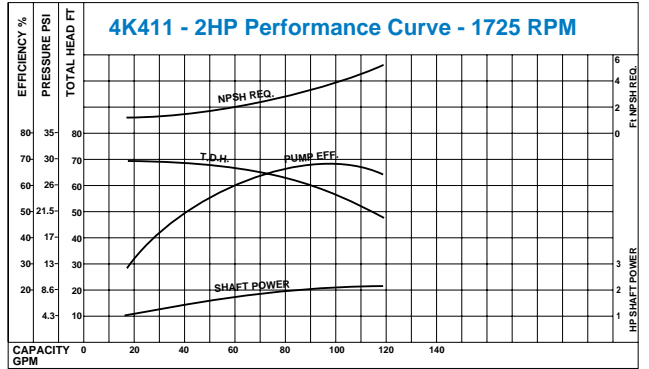
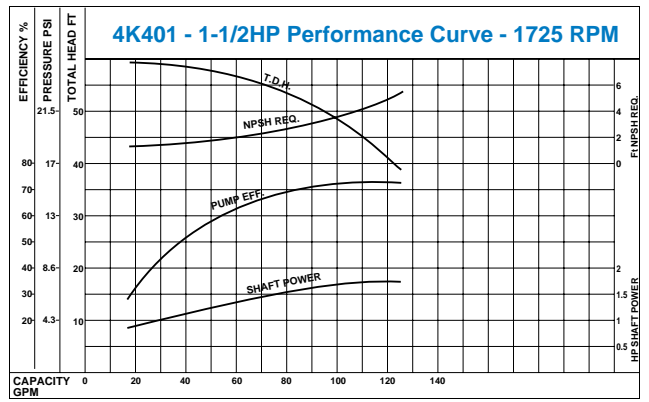

SELECTION CHART - 3450 RPM

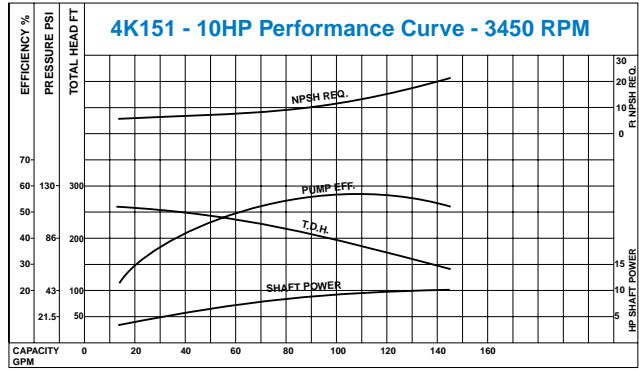
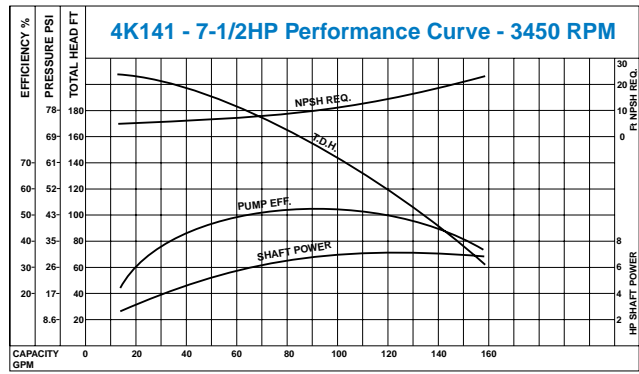
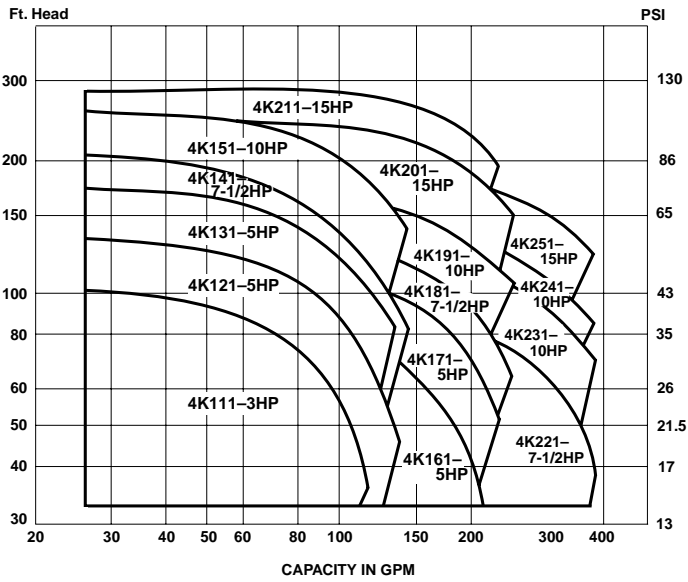

All calculations based upon water @ Spec. Gravity of 1.00

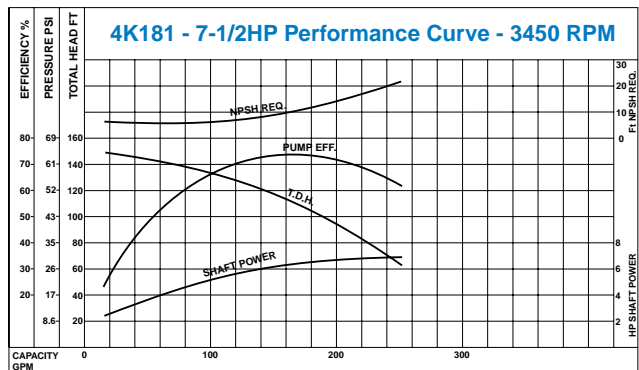
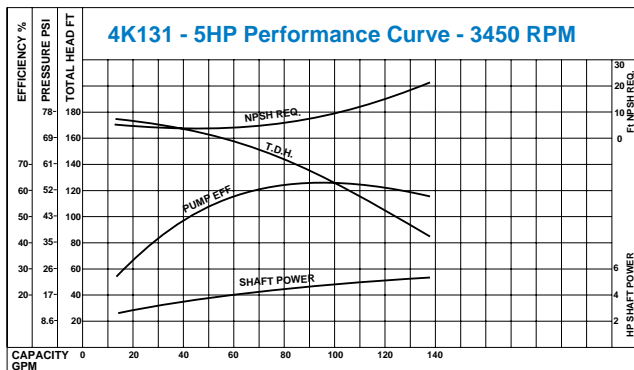
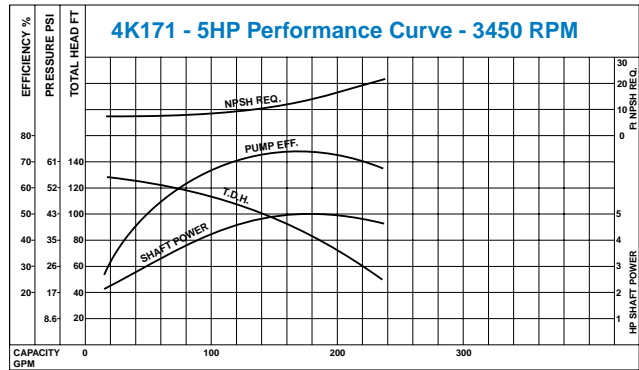
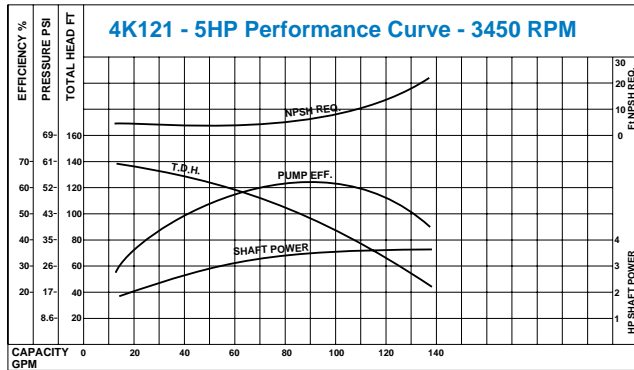
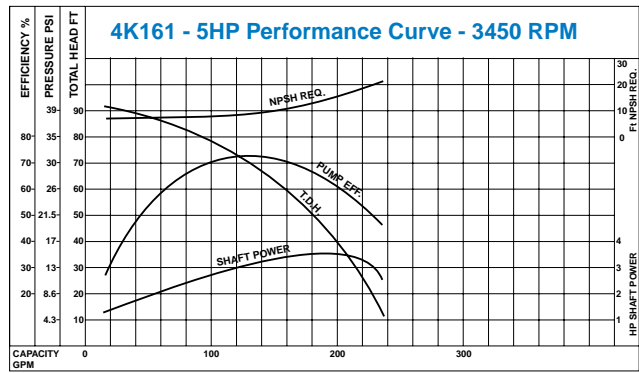
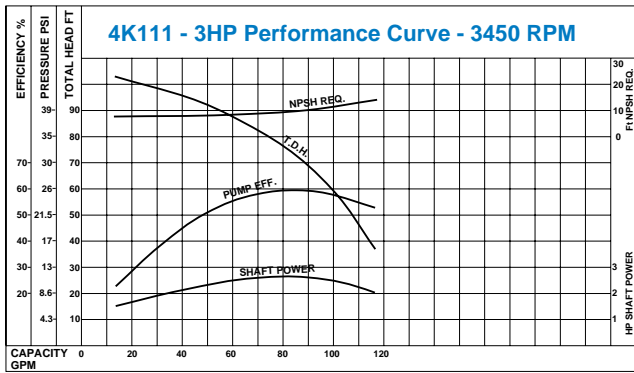

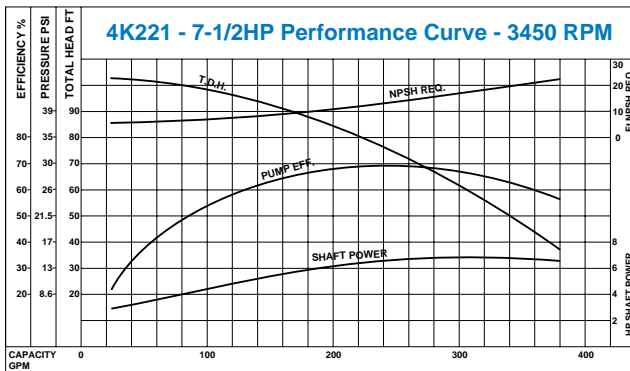
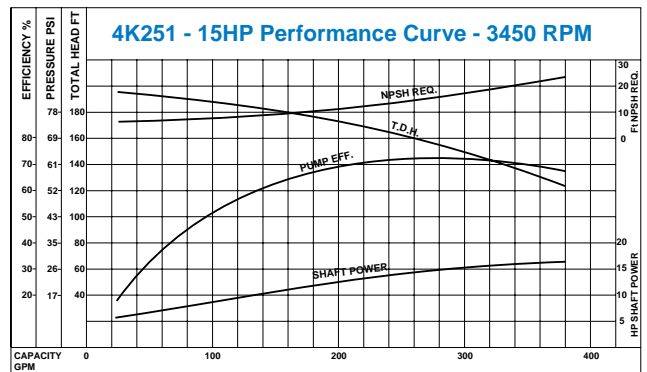
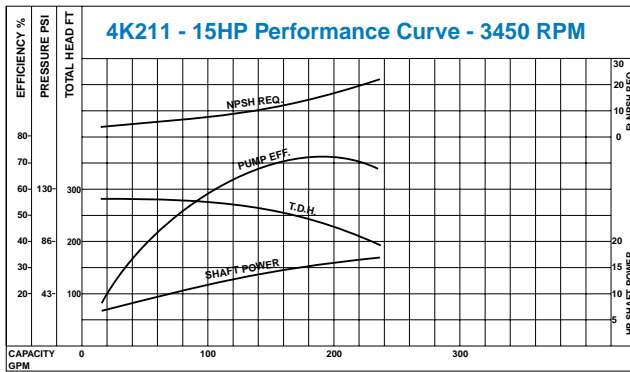
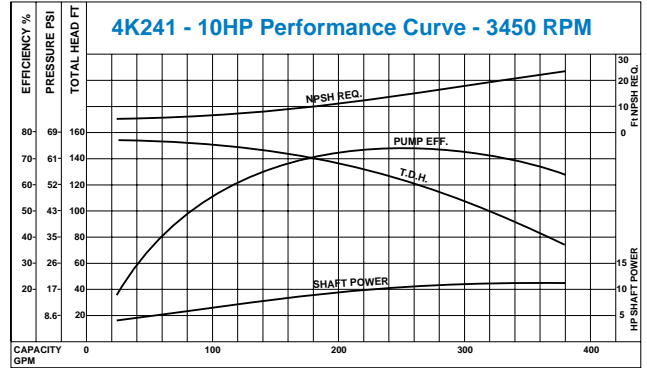
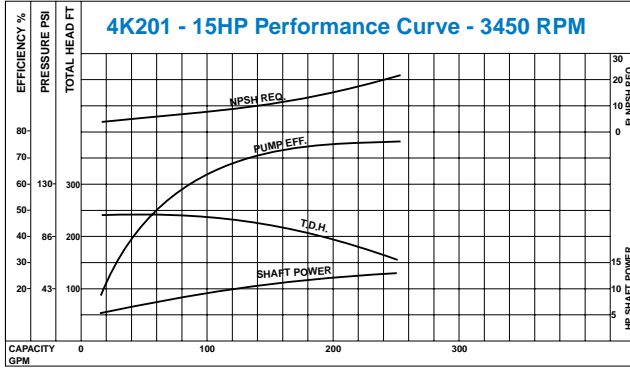
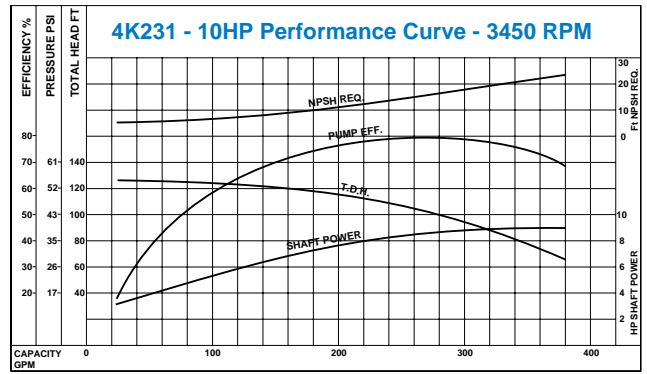
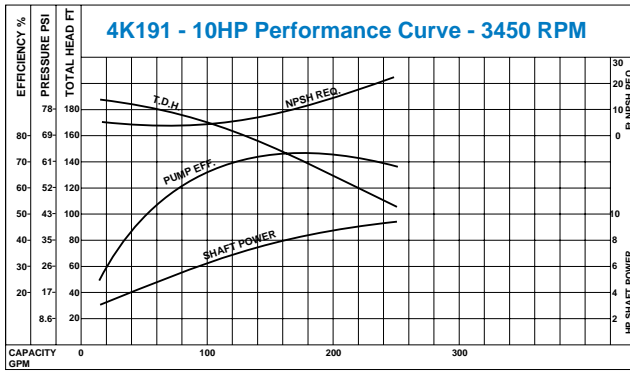

GENERAL SAFETY AND OPERATION

SELECTION: Review the Selection Chart to find the performance range and pump model suited to your application requirements. Then review the Performance Curve Chart to verify the most efficient performance and inlet conditions required.

INSTALLATION: These pumps may be installed in either a horizontal (most common) or vertical position (as installation requires). The following criteria should be considered to assure optimum performance:

- Proper alignment of plumbing
- Adequate line size to prevent starvation
- Rigid metal or plastic pipe or reinforced flexible plumbing to prevent collapsing lines
- Properly sealed connections to prevent air leaks
- Good filtration of the liquid to avoid abrasives and solids
- Foot valve may need to be installed at the inlet.

OPERATION: The pump comes with a standard seal for fresh water or non harsh liquids. Excessive pH, high viscosity and abrasives will affect the life and performance of the pump. Special shaft seals are available for high temperature or chemical duty applications. Check with factory for high viscosity liquids. Make certain there is sufficient liquid supply to the pump before starting operation.

MAINTENANCE: This is a low maintenance pump. The shaft seal and impeller are the primary service items. These can be easily replaced.

1. Remove the 8 or 10 hex head screws and slide the casing from the cover.
2. Remove the impeller bolt and gaskets then slide off impeller.
3. Carefully pry the casing cover away from the bracket.
4. Lay the cover on the work surface (large diameter up) and press out the shaft seal.
5. Turn the cover over on the work surface (small diameter up) and press the **back half** (stationary half) of the new shaft seal into position until completely seated in the chamber with the **elastomer side down**.

CAUTION

Exercise care when handling the shaft seal. It can be easily contaminated by improper handling and will not properly seal. Use the paper cover to press the seal into position and toss the cover when done.

NOTE: If seal installation is tight, carefully apply a small amount of lubricant to the **outer edge** (non-chlorine dish soap). **DO NOT USE OIL OR GREASE.**

6. Align the cover with the holes on the bracket and press into position.

7. Slide the **front half** of the seal (rotating half) onto the shaft sleeve with the **elastomer side out** (carbon/ceramic surfaces mating). Then slide the seal spring and washer onto the shaft.
8. Hold the seal spring in place, and then place gasket on top of spring retainer. Slide the impeller into position until completely seated.

NOTE: Use a screwdriver to hold the motor shaft stationary.

9. Install the impeller bolt and gasket onto the shaft and torque per chart. Rotate the impeller to assure proper alignment before installing the cover.

NOTE: Apply Loctite®609 to the impeller bolt before installing.

10. Place the new O-Ring over the casing cover. Exercise caution not to cut or twist the O-Ring during installation.
11. Replace the casing cover. Align discharge port in the upward position, and then align mounting holes. Replace 8 or 10 lockwashers, nuts and hex head screws and torque per chart.

Loctite is a registered trademark of the Henkel Corporation.

TORQUE CHART

	Size	Torque		
		ft. lbs.	in. lbs.	Nm
Impeller Bolt	3/8-16	12-18	144-215	16-24
Pump Casing	M8 x 30 Hex Head Screw or	8.0	96	10.8
	M10 x 35 Hex Head Screw	8.0	96	10.8
(To Motor Bracket)	M8 Ext. Tooth Lockwasher or M10 Ext. Tooth Lockwasher			
Motor Bracket	3/8" -16 x 1" Hex Head Screw or	8.0	96	10.8
	1/2"-13 x 1-3/4" Hex Head Screw	8.0	96	10.8
(To Motor)	3/8" Ext. Tooth Lockwasher or 1/2" Ext. Tooth Lockwasher			

TROUBLESHOOTING

PROBLEM	SOLUTION
• No flow or low flow	• Check rotation of pump • Check liquid supply to pump
• Leaking	• Replace shaft seal • Check case cover o-ring
• Noise	• Check liquid supply to pump • Check viscosity of liquid • Review NPSH requirements
• Vibration	• Secure plumbing to and from pump • Check impeller and replace as needed

WARRANTY

This pump is warranted for one year from date of purchase.
Improper installation and use will void the warranty.

Products described hereon are covered by one or more of the following U.S. patents 3558244, 3652188, 3809508, 3920356, 3930756 and 5035580

World Headquarters

CAT PUMPS

1681 - 94th Lane N.E. Minneapolis, MN 55449-4324

Phone (763) 780-5440 — FAX (763) 780-2958

e-mail: techsupport@catpumps.com

www.catpumps.com

International Inquiries

FAX (763) 785-4329

e-mail: intlsales@catpumps.com



The Pumps with Nine Lives

CAT PUMPS (U.K.) LTD.

1 Fleet Business Park, Sandy Lane, Church Crookham

FLEET, Hampshire, GU52 8BF, England

Phone Fleet 44 1252-622031 — Fax 44 1252-626655

e-mail: sales@catpumps.co.uk

N.V. CAT PUMPS INTERNATIONAL S.A.

Heiveldkens 6A, B-2550 Kontich, Belgium

Phone 32-3-450.71.50 — Fax 32-3-450.71.51

e-mail: cpi@catpumps.be www.catpumps.be

CAT PUMPS DEUTSCHLAND GmbH

Buchwiese 2, D-65510 Idstein, Germany

Phone 49 6126-9303 0 — Fax 49 6126-9303 33

e-mail: catpumps@t-online.de www.catpumps.de