

# REFERENCE BULLETIN

## PUMP IDENTIFICATION



REF 004

### How to Identify Your Pump – Cylinder and Plunger Reference Chart

All Cat Pumps have a label on the pump to identify the model. If your pump has no model number label, you can identify your pump by either removing and measuring the cylinder on piston pumps or by removing and measuring the ceramic plunger on plunger pumps (see photos below). The charts on the following pages cover cylinder dimensions and crankshaft identification stamps for current piston pumps and obsolete piston pumps, ceramic plunger dimensions and crankshaft identification stamps for current ceramic plunger pumps and obsolete ceramic plunger pumps. The final two pages cover conversion model numbering and how to interpret these numbers.

Please note the serial number stamped into the lower side of the crankcase above the mounting flange is not intended for pump identification. This date is the production date and can assist you in determining “Effective Dates” for changes in pump construction, performance or design which can be found in our Technical Bulletins.

#### Piston Pump

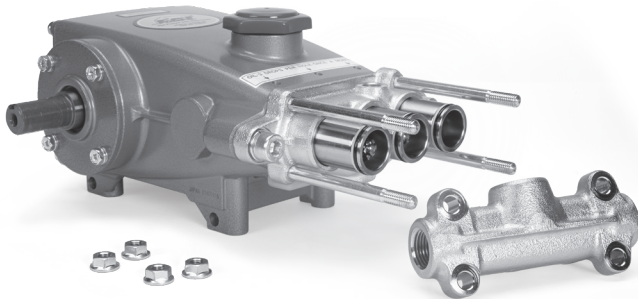

#### Plunger Pump

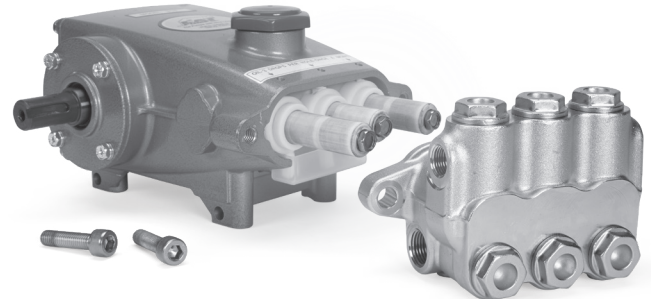

### Crankshaft Identification Stamp Location

#### Solid Shaft Pumps

All piston and plunger pumps except 10 Frame and larger pumps where only 1 stroke option is used.

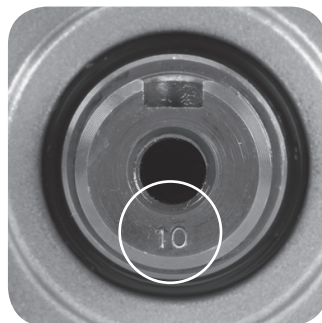

#### Hollow Shaft Pumps

1CX, 1DX, 2DX, 2SF, 2SFX, 3DNX, 3DX, 3SP, 3SPX, 4DNX, 4DX, 4HP, 4SF, 4SPX, 5DX, 5SP, 6DX, 66DX, 67DX, Series Pumps

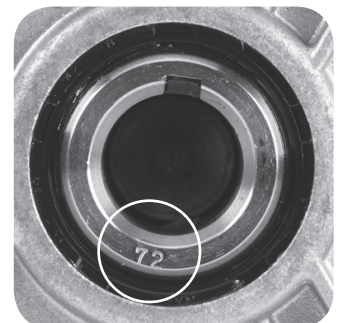

# Piston Pumps

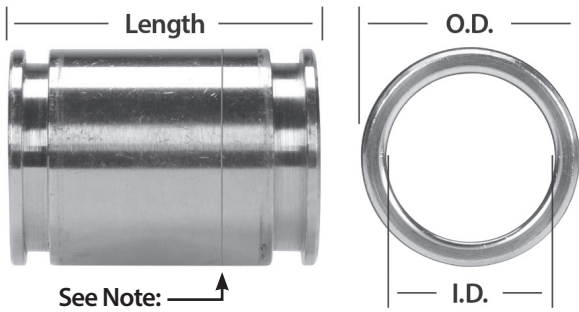

1. Remove pump discharge manifold to access cylinder.
2. Measure the length of cylinder, inside diameter (I.D.) and outside diameter (O.D.) of cylinder as shown.
3. Identify the stroke of the crankshaft. The stroke is stamped (mm) on the end of the crankshaft.
4. Using information from steps 2 and 3, use the Cylinder Dimensional Reference Chart to identify piston pump.

**NOTE:** Models 333, 430, 623, 820, 1010 can be identified without removing the discharge manifold by looking for the machined groove on the discharge end of cylinder.

Model 333 has one machined groove  
Model 430 has no machined groove

Model 623 has one machined groove  
Model 820 has two machined grooves

Model 1010 has no machined groove

## Piston Pumps – Cylinder Dimensional Reference Chart

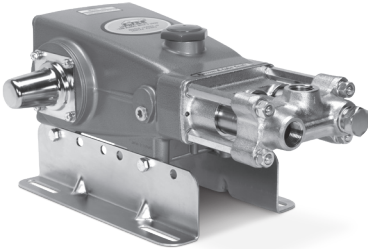

MODEL	CYLINDER PART NUMBER	LENGTH Inches	LENGTH mm	I.D. Inches	I.D. mm	O.D. Inches	O.D. mm	CRANKSHAFT I.D. STAMP
280	26112	1.181	30	0.787	20	1.024	26	10
290/291*	101802	1.378	35	0.787	20	1.024	26	13
323	43768	1.575	40	0.866	22	1.142	29	18
333/331*	25660	1.575	40	0.709	18	1.024	26	20.5
430/431*	24285	1.575	40	0.787	20	1.024	26	20.5
820/821*	28340	1.969	50	0.984	25	1.417	36	**
1010/1011*	28341	1.969	50	1.122	28.5	1.417	36	**
623/621*	28342	1.969	50	0.787	20	1.417	36	**
390	44288	2.205	56	1.260	32	1.398	35.5	18
2520/2520C*	27844	2.559	65	1.496	38	1.850	47	**
6020/6021*	29466	4.409	112	2.205	56	2.559	65	**
6040/6041*	43204	4.409	112	1.811	46	2.559	65	**

## Obsolete Piston Pumps – Cylinder Dimensional Reference Chart

MODEL	PART NUMBER	LENGTH Inches	LENGTH mm	I.D. Inches	I.D. mm	O.D. Inches	O.D. mm	CRANKSHAFT I.D. STAMP
284	27877	1.319	33.5	0.787	20	1.024	26	10
410	24285	1.575	40	0.787	20	1.024	26	20.5
420	24285	1.575	40	0.787	20	1.024	26	20.5
260	24285	1.575	40	0.787	20	1.063	27	**
300	25660	1.575	40	0.709	18	1.024	26	**
330	25660	1.575	40	0.709	18	1.024	26	20.5
520	28763	1.969	50	0.709	18	1.417	36	**
400	22161	2.047	52	0.787	20	1.024	26	20.5
500	21984	2.047	52	0.787	20	1.024	26	**
1020/1021*	27823	2.559	65	0.984	25	1.850	47	**
1520/1521*	27817	2.559	65	1.122	28.5	1.850	47	**
2020/2021*	28533	2.559	65	1.260	32	1.850	47	**
2521*	27844	2.559	65	1.496	38	1.850	47	**
1000	20253	2.559	65	1.122	28.5	1.260	32	**
524	43131	2.579	65.5	1.020	25.9	1.496	38	**
1024	28673	2.598	66	1.102	28	1.772	45	**
1044	29080	2.677	68	1.339	34	1.772	45	**
624	43264	3.071	78	0.945	24	1.260	32	**
2500	13632	3.346	85	1.500	38.1	1.677	42.6	**
6024	43118	6.496	165	1.500	38	2.756	70	**
6044	43119	6.496	165	1.850	47	2.756	70	**

\* See model number breakdown for individual model number.

\*\* I.D. number is not stamped on end of crankshaft.

# Plunger Pumps

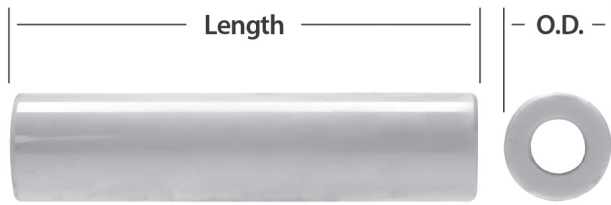

1. Remove pump manifold(s) to access ceramic plunger.
2. Measure the length of ceramic plunger and outside diameter as shown.
3. Identify the stroke of the crankshaft. The stroke is stamped (mm) on the end of the crankshaft for both hollow shaft and solid shaft models.
4. Using information from steps 2 and 3, use the Ceramic Dimensional Reference Chart to identify plunger pump.

**NOTE:** If you have a hollow shaft pump, you will need to remove pump from engine/motor to identify stroke.

## Plunger Pumps – Ceramic Dimensional Reference Chart

MODEL	CERAMIC PN	LENGTH Inches	LENGTH MM	O.D. Inches	O.D. mm	CRANKSHAFT I.D. STAMP
2SF10ES	45847	0.551	14.0	0.709	18	18
2SF20ES/2SFX20ES*	45847	0.551	14.0	0.709	18	31
2SF22ES	45847	0.551	14.0	0.709	18	335
2SF30ES/2SFX30ES*	45847	0.551	14.0	0.709	18	45
2SF30GS/2SFX30GS/ 2SFX30GZ*	45847	0.551	14.0	0.709	18	48
2SF35ES/2SF35GS*	45847	0.551	14.0	0.709	18	56
2SF22ELS*	45847	0.551	14.0	0.709	18	63
2SF29ELS*	45429	0.663	16.0	0.709	18	85
2SF05SEEL	544697	0.709	18.0	0.709	18	18
2SF10SEEL	544697	0.709	18.0	0.709	18	31
2SF15SEEL	544697	0.709	18.0	0.709	18	45
2SF22SEEL	544697	0.709	18.0	0.709	18	63
2SFQ25SEEL	544697	0.709	18.0	0.709	18	73
2SFQ29SEEL	544697	0.709	18.0	0.709	18	85
2SFQ35SEEL	544697	0.709	18.0	0.709	18	102
2SFQ42SEEL	831290	0.709	18.0	0.787	20	102
4SP21EL/4SP21ELR/4SP21ELU	132606	0.969	24.6	0.630	16	83
4SP29ELR/4SP29ELU	133988	0.969	24.6	0.709	18	85
4DNX25GSI	547091	1.004	25.5	0.551	14	68
4DNX27GSI	547091	1.004	25.5	0.551	14	72
4SPX32G1I	547091	1.004	25.5	0.551	14	83
1CX013R/4DX10ER*	542403	1.063	27.0	0.630	16	20
4DX15ER	542403	1.063	27.0	0.630	16	30
1CX025R	542403	1.063	27.0	0.630	16	33
4DX20ER	542403	1.063	27.0	0.630	16	40
4DX27ER	542403	1.063	27.0	0.630	16	56
4DX30ER	542403	1.063	27.0	0.630	16	62
1CX050R	542403	1.063	27.0	0.630	16	63
67DX39G1I	49367	1.102	28.0	0.551	14	103

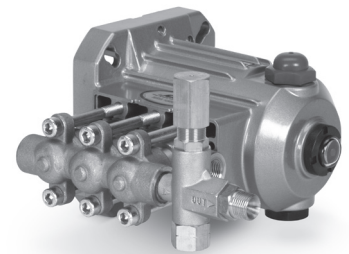

2SF Plunger Pumps

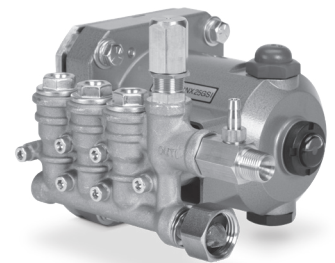

4DNX Plunger Pumps

\* See model number breakdown for individual model number.

\*\* I.D. number is not stamped on end of crankshaft.

## Plunger Pumps – Ceramic Dimensional Reference Chart

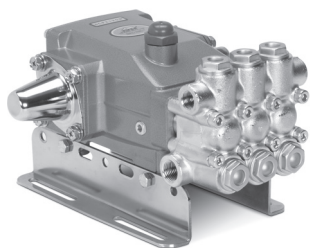

CP Plunger Pumps

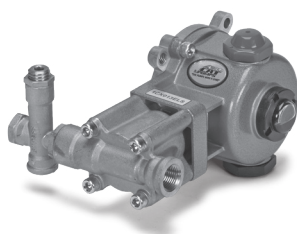

1CX Plunger Pumps  
(Single Plunger)

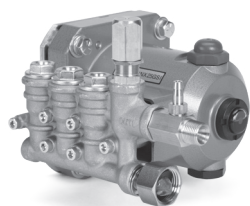

DX Plunger Pumps

MODEL	CERAMIC PN	LENGTH Inches	LENGTH MM	O.D. Inches	O.D. mm	CRANKSHAFT I.D. STAMP
5SP30ELR/5SP30ELU	134351	1.181	30.0	0.630	16	11
5SP35ELR/5SP35ELU	134346	1.299	33.0	0.709	18	11
5SP40ELR/5SP40ELU	134333	1.299	33.0	0.787	20	11
5CP4120CSS	49906	1.614	41.0	0.591	15	20
5CP4110CSS	49906	1.614	41.0	0.591	15	10
5CP4112CSS	49906	1.614	41.0	0.591	15	12
5CP4114CSS	49906	1.614	41.0	0.591	15	14
5CP4116CSS	49906	1.614	41.0	0.591	15	165
5CP4118CSS	49906	1.614	41.0	0.591	15	18
230/231/237*	43901	1.693	43.0	0.709	18	73
3CP1211CS	46976	1.693	43.0	0.709	18	15
3CP1130/3CP1231*	46976	1.693	43.0	0.709	18	73
240/241/247*	43901	1.693	43.0	0.709	18	11
3CP1140/3CP1241*	46976	1.693	43.0	0.709	18	11
270/271/277*	43901	1.693	43.0	0.709	18	127
3CP1120/3CP1221*	46976	1.693	43.0	0.709	18	127
66DX30G11	48752	1.850	47.0	0.551	14	86
66DX35G11	48752	1.850	47.0	0.551	14	10
66DX40G11	48752	1.850	47.0	0.551	14	114
5CP2140WCS/5CP2140BCS/ 5CPQ6241CS*	46841	1.969	50.0	0.787	20	10
5CP3105CSS	46884	1.969	50.0	0.630	16	10
5CP2150W/5CP2150B/5CPQ6251*	46841	1.969	50.0	0.787	20	12
5CP3110CSS	46884	1.969	50.0	0.630	16	14
5CP3160CSS	46884	1.969	50.0	0.630	16	165
5CP2120W/5CP2120B/5CP6120/ 5CPQ6221*	46841	1.969	50.0	0.787	20	18
5CP3120/5CP3120CSS*	46884	1.969	50.0	0.630	16	18
5CP5120/ 5CP5120CSS	49655	1.969	50.0	0.709	18	18
5CP5140CSS*	49655	1.969	50.0	0.709	18	20
5CP6180CSS	121391	1.969	50.0	0.866	22	165
5CP6190	121391	1.969	50.0	0.866	22	20
7CP6160CS	134938	2.086	53.0	0.707	20	26
7CP6110CS/7CP6111CS/7CP6111CSS*	48559	2.165	55.0	0.866	22	217
7CP6170/7CP6171CS/7CP6171CS*	48559	2.165	55.0	0.866	22	26
1540E/1540EC/1541/1541C*	48938	2.559	65.0	1.181	30	**
30	43367	2.835	72.0	0.787	20	8
340/340B/340S/341/347*	43367	2.835	72.0	0.787	20	10
350/350B/350S/351/357*	43367	2.835	72.0	0.787	20	12
740/784KM	45890	2.835	72.0	0.551	14	15
310/310B/310S/311/311C/ 341/341C/351C/351*	43367	2.835	72.0	0.787	20	18
45	45783	2.835	72.0	0.630	16	18
700/781/781K/781KM*	45890	2.835	72.0	0.551	14	24
760	45890	2.835	72.0	0.551	14	185
60	43232	3.031	77.0	0.709	18	15
57	43232	3.031	77.0	0.709	18	185
56/530*	43232	3.031	77.0	0.709	18	24
550	43311	3.031	77.0	0.630	16	24
650/660/661C/661D/1560/ 1050/1051/1051C/1051D/1057/1580*	43552	3.031	77.0	0.945	24	**
1810/1810K*	76595	3.142	79.8	0.433	11	**
1570	132150	3.268	83.0	0.630	16	**
1530/1530C/1531*	48606	3.622	92.0	0.984	25	**
2530/2530E/2531/2531C/2537/2831/2831K*	45749	3.661	93.0	1.260	32	**
3550	132953	4.331	110.0	0.787	20	**
2510/2511/3560*	48535	4.331	110.0	0.984	25	**
6810	76347	4.803	122.0	0.827	21	**
3501/3501C/3507/3507C/3801/3801K*	43945	5.709	145.0	0.787	20	**
3511/3511C/3517/3517C/3811/3811K*	43866	5.709	145.0	0.984	25	**
3520/3520C/3521DHS/3521C/3527/3570/ 3821HS/3821KHS/6821/6821K*	43957	5.709	145.0	1.260	32	**
3531D/3531C/3535/3535C/3537/3831/3831K*	43921	5.709	145.0	1.575	40	**
3541D/3541C/3545/3547/3547C/3841/3841K*	46806	5.709	145.0	1.772	45	**
6801/6801K/6811/6811K*	43866	5.709	145.0	0.984	25	**
6831/6831K/6832/6835/6835K*	43921	5.709	145.0	1.575	40	**
67070	134489	6.220	158.0	1.772	45	**
67102/67102C*	133721	6.850	174.0	2.440	62	**
6747/6841/6841K*	45672	7.283	185.0	1.772	45	**
6760/6761/6762/6767/6767C/6775/ 6861/6861K*	44749	7.283	185.0	2.165	55	**

\* See model number breakdown for individual model number.

\*\* I.D. number is not stamped on end of crankshaft.

## Obsolete Plunger Pumps – Ceramic Dimensional Reference Chart

MODEL	CERAMIC PN	LENGTH Inches	LENGTH MM	O.D. Inches	O.D. mm	CRANKSHAFT I.D. STAMP
2SFX22ES*	45847	0.551	14.0	0.709	18	335
4SF30GS1	45848	0.945	24.0	0.787	20	44
4SF35GS1	45848	0.945	24.0	0.787	20	50
4SF40GS1	45848	0.945	24.0	0.787	20	57
4SF45GS1	45848	0.945	24.0	0.787	20	65
4SF50GS1	45848	0.945	24.0	0.787	20	70
4SF32ELS	45848	0.945	24.0	0.787	20	79
4SF40ELS	45848	0.945	24.0	0.787	20	97
4SF45ELS	45848	0.945	24.0	0.787	20	111
4SF50ELS	45848	0.945	24.0	0.787	20	115
3DNX25GSI	547091	1.004	25.5	0.551	14	68
3DNX27GSI	547091	1.004	25.5	0.551	14	72
3SP30G1I/3SPX30G1I*	547091	1.004	25.5	0.551	14	8
3SP35GEI/3SPX35GEI*	547091	1.004	25.5	0.551	14	88
1DX015ELS.MIST/1DX03ELS.MIST/ 2DX05ELS.MIST*	542403	1.063	27.0	0.630	16	20
2DX15ES/2DX15ES.MIST*	542403	1.063	27.0	0.630	16	30
2DX20ES/2DX20ES.MIST*	542403	1.063	27.0	0.630	16	40
3DX25GSI	542403	1.063	27.0	0.630	16	52
2DX27ES/2DX27ES.MIST/ 3DX27GSI*	542403	1.063	27.0	0.630	16	56
3DX29GSI	542403	1.063	27.0	0.630	16	59
2DX30ES/2DX30ES.MIST/ 3DX30GSI*	542403	1.063	27.0	0.630	16	62
2DX30GS	542403	1.063	27.0	0.630	16	64
3CP1131	46976	1.693	43.0	0.709	18	73
3CP1141	46976	1.693	43.0	0.709	18	11
3CP1121	46976	1.693	43.0	0.709	18	127
5DX30G1	46727	1.850	47.0	0.630	16	64
4HP35G1/5DX35G1*	46727	1.850	47.0	0.630	16	79
4HP40G1/5DX40G1*	46727	1.850	47.0	0.630	16	9
6DX35G1I	48752	1.850	47.0	0.551	14	10
5DX50G1	46727	1.850	47.0	0.630	16	112
6DX40G1I	48752	1.850	47.0	0.551	14	114
5CP6141/5CP6241CS	46841	1.969	50.0	0.787	20	10
5CP6151/5CP6251	46841	1.969	50.0	0.787	20	12
5CP5150	49655	1.969	50.0	0.709	18	16
5CP5140	49655	1.969	50.0	0.709	18	20
5CP3130	46884	1.969	50.0	0.630	16	165
5CP6121/5CP6221	46841	1.969	50.0	0.787	20	18
1540	48938	2.559	65.0	1.181	30	30
42HS	45783	2.835	72.0	0.630	16	85
34/340W*	43367	2.835	72.0	0.787	20	10
43HS	45890	2.835	72.0	0.551	14	11
35/350W*	43367	2.835	72.0	0.787	20	12
31/310W*	43367	2.835	72.0	0.787	20	18
70	45890	2.835	72.0	0.551	14	24
58	43232	3.031	77.0	0.709	18	17
51	43311	3.031	77.0	0.630	16	185
59	43232	3.031	77.0	0.709	18	185
55	43311	3.031	77.0	0.630	16	24
53	43232	3.031	77.0	0.709	18	24
654	43232	3.031	77.0	0.709	18	**
651/681/681K/1861/1861K/1861KM*	43300	3.031	77.0	0.787	20	**
1851/1851K*	43552	3.031	77.0	0.945	24	**
3510	43945	5.709	145.0	0.787	20	**
3515	43866	5.709	145.0	0.984	25	**
6771/6777	44749	7.283	185.0	2.165	55	**

\* See model number breakdown for individual model number.

\*\* I.D. number is not stamped on end of crankshaft.

## Pump Model Number Breakdown

When a pump model has been identified, the model and its suffix provide more information about the pump.

Whether it is the manifold material or manifold configuration, seals or o-rings material, shaft sizes, electric or gas drives, etc. please read below.

**The last numerical digit in a three or more digit model number indicates specific manifold material, manifold configuration, cups or cylinders/sleeves.**

Suffix	Examples	
<b>0</b>		<b>Base models equipped with Buna-N seals and O-rings</b>
	280	Piston pump
	310	Plunger pump
<b>1</b>		<b>316 Stainless steel manifolds</b>
	281	304 Stainless steel valves - piston pumps
	311	316 Stainless steel valves - plunger pumps
<b>2</b>		<b>Piston pumps</b>
	432	Unchromed 304 stainless steel cylinders, sleeves and manifolds
		<b>Plunger pumps</b>
	6762	Duplex stainless steel manifolds
<b>3</b>		<b>Piston pumps</b>
	333	Machined high pressure cups, standard manifold
<b>4</b>		<b>Plunger pumps</b>
	6864	Super duplex stainless steel block-style manifolds
<b>5</b>		<b>Piston pumps</b>
	335	Pulse ported discharge manifold
<b>6</b>		<b>Piston pumps</b>
	436	Unchromed 304 stainless steel cylinders and sleeves, standard manifold
<b>7</b>		<b>Nickel Aluminum Bronze</b>
	317	Plunger Pump

**The last three or four alpha characters in a three or more digit model number covers a wide range of options as noted.**

<b>B</b>		<b>Special formulated brass manifolds</b>
	5CP2120B	Plunger pump
<b>C</b>		<b>Flushed inlet manifold</b>
	2520C	Piston pump
	311C	Plunger pump
<b>C1</b>		<b>Clutch pump - 1 groove</b>
	290C1	Piston pump
	340C1	Plunger pump
<b>C2</b>		<b>Clutch pump - 2 grooves</b>
	290C2	Piston pump
	340C2	Plunger pump
<b>CS</b>		<b>Single shaft, right side</b>
	3CP1120CS	Plunger pump
<b>CSS</b>		<b>Single shaft, right side, side gauge left</b>
	5CP3120CSS	Plunger pump
<b>D</b>		<b>Duplex stainless steel</b>
	661D	Plunger pump
<b>E</b>		<b>Epoxy painted, special liquid gasket</b>
	1540E	Plunger pump
<b>EES</b>		<b>Direct drive - electric, 5/8" hollow shaft, no unloader, 3450 RPM</b>
	2SF10EES	
<b>EL</b>		<b>Direct drive - electric, 5/8" hollow shaft, no unloader, 1750 RPM</b>
	4SP21EL	Plunger pump

<b>Suffix</b>	<b>Examples</b>	
<b>ELS</b>	2SF22ELS 4SF40ELS	<b>Direct drive - electric, with unloader, 1725 RPM</b> Plunger pump - 5/8" hollow shaft Plunger pump - 1 1/8" hollow shaft
<b>ER</b>	4DX10ER	<b>Direct drive - electric, 5/8" hollow shaft, integral regulator, 3450 RPM</b> Plunger pump
<b>ES</b>	2SF22ES	<b>Direct drive - electric, 5/8" hollow shaft, with unloader, 3450 RPM</b> Plunger pump
<b>EUF</b>	4DX15EUF	<b>Direct drive - electric, 5/8" hollow shaft, integral unloader, garden hose fitting, 3450 RPM</b> Plunger pump
<b>G</b>	3CP1120G	<b>Gearbox pump - 3/4" shaft</b> Plunger pump
<b>G1</b>	45G1	<b>Gearbox pump - 1" shaft</b> Plunger pump
<b>G118</b>	45G118	<b>Gearbox pump - 1 1/8" shaft</b> Plunger pump
<b>G1I</b>	66DX40G1I	<b>Direct drive - gas, 1" hollow shaft, with unloader, chemical injector, 3400 RPM</b> Plunger pump
<b>GES</b>	2SF30GES	<b>Direct drive - electric, 3/4" hollow shaft, with unloader, 3450 RPM</b> Plunger pump
<b>GG1</b>	66DX40GG1	<b>Direct drive - gas, 1" hollow shaft, no unloader, 3400 RPM</b> Plunger pump
<b>GS</b>	2SF30GS	<b>Direct drive - gas, 3/4" hollow shaft, with unloader, 3450 RPM</b> Plunger pump
<b>GSI</b>	4DNX25GSI	<b>Direct drive - gas, 3/4" hollow shaft, chemical injector, integral unloader, 3450 RPM</b> Plunger pump
<b>GZ</b>	2SF30GZ	<b>Direct drive - gas, 3/4" hollow shaft, with unloader, 3450 RPM</b> Plunger pump
<b>HS</b>	3507HS	<b>High strength drive-end</b> Plunger pump
<b>HYD</b>	3K121HYD	<b>Hydraulic powered pump unit</b> Centrifugal pump
<b>K</b>	781K	<b>Flushed Block-Style inlet manifold</b> Plunger pumps
<b>P</b>	1560P	<b>Manifold with pulsator port</b> Plunger pump
<b>RS</b>	56RS	<b>Reverse shaft</b> Plunger pumps
<b>RSS</b>	5CP3160RSS	<b>Reverse shaft left side, side gauge right side</b> Plunger pumps
<b>S</b>	310S	<b>Solid stainless steel inserts</b> Plunger pumps
<b>SEEL</b>	2SF22SEEL	<b>Direct drive - electric, 5/8" hollow shaft, no unloader, 1725 RPM, SS Manifolds</b> Plunger pump
<b>W</b>	5CP2120W	<b>Special W770 alloy manifolds</b> Plunger pumps

The suffix numbering following the period after the base number covers valves (flat), inverting manifolds, seals, cups and o-rings:

Suffix	Examples	
<b>.0001</b>	820.0001	<b>Flat valve assemblies found in piston pumps</b> Standard in 25 and 60 frame piston pumps (Quiet valves in 3, 4, 5 and 10 frame piston pumps, must convert)
<b>.0005</b>	333.0005	<b>Inverted inlet and discharge manifolds on both piston and plunger pumps</b>
<b>.0008</b>	290.0008	<b>Inverted inlet manifolds on both piston and plunger pumps</b>
<b>.0009</b>	390.0009	<b>Inverted discharge manifolds on both piston and plunger pumps</b>
<b>.0090</b>	781K.0090	<b>Piston or plunger pumps with 90 duro o-rings</b>
<b>.0100</b>	280.0100	<b>Piston or plunger pumps with Fluorocarbon (FPM) seals</b>
<b>.0110</b>	310.0110	<b>Piston or plunger pumps with FPM seals and o-rings</b>
<b>.0220</b>	310.0220	<b>Piston or plunger pumps with Ethylene Propylene Diene Monomer (EPDM) seals and o-rings</b>
<b>.0300</b>	333.0300	<b>Piston pumps with Blue Dot Seals</b>
<b>.0700</b>	1050.0700	<b>Piston or plunger pumps with Pure Polytetrafluoroethylene (PTFE) seals and Medium Nitrile (Buna-N) (NBR) o-rings</b>
<b>.0710</b>	1810.0710	<b>Piston or plunger pumps with PTFE seals and FPM o-rings</b>
<b>.0770</b>	3511.0770	<b>Piston or plunger pumps with PTFE seals and Isolast o-rings</b>
<b>.0777</b>	3531.0777	<b>Piston or Plunger pumps with PTFE seals and PTFE back-up rings, o-rings</b>
<b>.3000</b>		<b>High pressure cups or seals</b>
	430.3000	Piston pump - V-Hot Cups
	56.3000	Plunger pump - High Temperature High Pressure Seal
<b>.3400</b>	3CP1130.3400	<b>Plunger pump high temperature high pressure seal or V-Packing, Special Blend PTFE low pressure seals</b>
<b>.3410</b>	1051.3410	<b>Plunger pump high temperature high pressure seal or V-Packing, Special Blend PTFE low pressure seals, FPM o-rings</b>
<b>.4400</b>	1540E.4400	<b>Piston or plunger pumps with Special Blend PTFE high and low pressure seals</b>
<b>.4410</b>	241.4410	<b>Plunger pumps with Special Blend PTFE high and low pressure seals, FPM o-rings</b>
<b>.44101</b>		<b>Plunger pump seals and o-rings</b>
	1050.44101	Special Blend Polytetrafluorethylene high pressure and low pressure seals, FPM o-rings, FPM c/case seals and o-rings
<b>.6000</b>	1051.6000	<b>Piston or plunger pumps with Silicone Free seals and o-rings</b>
<b>.9000</b>	550.9000	<b>Piston or plunger pumps - rebuilt</b>

Cat Pumps configures a number of pumps for special applications and certifications such as ATEX, CO2, TEG, Flushed, High-Temperature and others. Please contact Cat Pumps directly at (763) 780-5440 for more information.



**CAT PUMPS**  
 1681 - 94TH LANE N.E. MINNEAPOLIS, MN 55449-4324  
 PHONE (763) 780-5440 — FAX (763) 780-2958  
 e-mail: techsupport@catpumps.com  
 www.catpumps.com

For International inquiries go to [www.catpumps.com](http://www.catpumps.com) and navigate to the "Contact Us" link.