

DATA SHEET

4FR PISTON PUMPS



**Brass
Models**
333, 430

**Stainless Steel
Models**
331, 431

**Pulse Pump
Model**
435



Model 333 Shown
(Shaft protector and mounting rails sold separately)

SPECIFICATIONS	U.S. Measure	Metric Measure
Models 333, 331		
Flow	4.0 gpm	15 lpm
Pressure Range	100–1200 psi	6.9–83 bar
Pump RPM*	1070 rpm	1070 rpm
Bore	0.709"	18 mm
Models 430, 431, 435		
Flow	5.0 gpm	19 lpm
Pressure Range	100–1000 psi	6.9–69 bar
Pump RPM*	1040 rpm	1040 rpm
Bore	0.787"	20 mm

*Pump minimum is 100 rpm

FEATURES

- Triplex Uniflow design provides continuous forward liquid for smooth operation.
- Hard chrome-plated 304S cylinders and sleeves provide long life with mild liquids within a range of 5–9 Ph.
- Optional 316 stainless steel manifolds provide added strength and corrosion resistance.
- Pump comes standard with NBR seals. Alternative seal materials are available for higher temperature or chemical compatibility.

COMMON SPECIFICATIONS

	U.S.	Metric
Stroke	0.768"	19.5 mm
Crankcase Capacity	21 oz	0.6 l
Max. Liquid Temperature (NBR)	160° F	71° C
Alternative seals available for higher temperatures up to 180° F		
Inlet Pressure Range	-8.5 to +40 psi	-0.6 to +2.8 bar
Inlet Port (1)	½" NPT(F)	½" NPT(F)
Auxiliary Port (1)	¼" NPT(F)	¼" NPT(F)
Discharge Ports (3)		
Top Port (1)	½" NPT(F)	½" NPT(F)
Front Ports (2)	⅜" NPT(F)	⅜" NPT(F)
Pulley Mounting	Either Side	Either Side
Shaft Diameter	0.650"	16.5 mm
Weight	17.7 lbs	8.0 kg
Dimensions	12.56 x 8.80 x 5.33"	319 x 223 x 135.5 mm

ALTERNATIVE SEAL CONFIGURATION

MATERIAL	SUFFIX CODE	MAXIMUM TEMPERATURE
NBR	—	160° F (71° C)
FPM	.0110	180° F (82° C)
HT	.3000	180° F (82° C)

See **Tech Bulletin 002** for inlet conditions and RPM at high-temperature.

DETERMINING THE PUMP RPM	Rated gpm	=	Desired gpm
	Rated rpm	=	Desired rpm
DETERMINING THE REQUIRED HP	hp	=	gpm x psi
	(Electric Brake)	=	1460
DETERMINING MOTOR PULLEY SIZE	Motor Pulley OD	=	Pump Pulley OD
	Pump rpm	=	Motor rpm

Refer to pump **Service Manual** for repair procedure and additional technical information.

PARTS LIST

ITEM	PART NUMBER		DESCRIPTION	QTY		
	333, 331	MATL 430,431, 435			MATL	
5	125824	STCP R	125824	STCP R	Screw, HHC Sems (M6 x 16) (See Tech Bulletin 074)	8
8	27950	AL	27950	AL	Cover, Bearing	2
10	26536	NBR	26536	NBR	O-Ring, Bearing Cover-70D	2
11	24159	NBR	24159	NBR	Seal, Oil	2
15	14487	STL R	14487	STL R	Bearing, Ball	2
20	48734	TNM	48734	TNM	Rod, Connecting, Assembly [3/02] (See Tech Bulletin 074)	3
25	43163	FCM	43163	FCM	Crankshaft, Dual End, Tapped (M8 x 1.25)	1
32	43211	ABS	43211	ABS	Cap, Oil Filler	1
33	14177	NBR	14177	NBR	O-Ring, Oil Filler Cap-70D	1
37	92241	PC	92241	PC	Gauge, Oil Bubble with Gasket-80D (See Tech Bulletin 074)	1
38	44428	NBR	44428	NBR	Gasket, Flat, Oil Gauge-80D	1
40	126541	STCP R	126541	STCP R	Screw, HHC Sems (M6 x 20) (See Tech Bulletin 074)	4
48	25625	STCP	25625	STCP	Plug, Drain (1/4" x 19 BSP)	1
49	23170	NBR	23170	NBR	O-Ring, Drain Plug-70D	1
50	48772	AL	48772	AL	Cover, Rear [10/04]	1
51	48773	NBR	48773	NBR	O-Ring, Cover [10/04]	1
53	76953	AL	76953	AL	Crankcase with Guide Pins [10/04]	1
55	126546	STCP R	126546	STCP R	Stud (M8 x 41.4)	4
56	27712	POP	27712	POP	<i>Pan, Oil (Use with Blue Dot Seals and Wick)</i>	1
64	16948	CM	16948	CM	Pin, Crosshead	3
65	27981	SZZ	27981	SZZ	Rod, Piston, Stepped	3
69	126259	STCP R	126259	STCP R	Washer, Oil Seal	3
70	25301	NBR	25301	NBR	Seal, Oil, Crankcase-80D	3
71	126189	STCP R	126189	STCP R	Washer, Oil Seal	3
75	25327	S	25327	S	Slinger, Barrier	3
77	25392	NBR	25392	NBR	O-Ring, Sleeve-70D	6
80	25299	SCP	25299	SCP	Sleeve	3
	28460	S	28460	S	<i>Sleeve Unchromed</i>	3
100	27710	PVDF	27710	PVDF	Retainer, Seal	3
101	27711	—	27711	—	<i>Wick, Long Tab (Use with Blue Dot Seals and Oil Pan)</i>	3
106	30315	NBR	30315	NBR	Seal, LPS, (Greased)	3
109	22177	BBCP	22177	BBCP	Plug, (1/4" NPT)	1
110	25128	BBCP	25128	BBCP	Manifold, Inlet (Models 333, 430)	1
	25635	SS	25635	SS	<i>Manifold, Inlet (Models 331, 431)</i>	1
118	22160	BBCP	22160	BBCP	Elbow, Street [1/2" NPT(M)]	3
119	28339	S	27004	S	Valve, Inlet	3
130	—	—	22021	S	Piston	3
133	28955	NBR	43172	FPM	Cup, Piston (Machined Cup-Models 331, 333)	3
135	27983	S	27983	S	Spacer, Piston	3
136	27002	S	27002	S	Retainer, Piston	3
137	27006	S	27006	S	Washer, Conical (M6)	3
138	27000	S	27000	S	Nut, Slotted (M6) (See Tech Bulletin 074)	3
139	14158	S	14158	S	Cotterpin (M1.6 x 10)	3
143	23172	NBR	23172	NBR	O-Ring, Cylinder-70D	6
150	25660	SCP	24285	SCP	Cylinder	3
	—	—	29044	S	<i>Cylinder Unchromed</i>	3
153	21985	PTFE	—	—	Backup Ring, Cylinder	3
164	43434	S	43434	S	Seat	3
166	43723	S	43723	S	Valve	3
167	43360	S	43360	S	Spring	3
168	43442	S	43442	S	Retainer, Spring	3
185	24459	BBCP	24459	BBCP	Manifold, Discharge (Models 333, 430)	1
	25634	SS	25634	SS	<i>Manifold, Discharge (Models 331, 431)</i>	1
	—	—	6400	BB	<i>Manifold, Pulse Pump (Model 435)</i>	1
186	126232	STCP R	126232	STCP R	Lockwasher (M8)	2
187	126564	STCP R	126564	STCP R	Bolt, Cylinder (M8)	2
188	126591	STCP R	126591	STCP R	Washer, Shim (M8 x 2 x 13)	2-4
189	126813	STCP R	126813	STCP R	Washer, Shim (M8 x 1 x 13)	2-4
190	126576	STCP R	126576	STCP R	Washer, Shim (M8 x .5 x 13)	2-4
191	126590	STZP	126590	STZP	Washer, Shim (M8 x .3 x 13)	2-4
192	26676	S	26676	S	Lockwasher (M8)	2
194	126201	STCP R	126201	STCP R	Nut, Hex Flange (M8) (See Tech Bulletin 074)	2
196	22187	BBCP	22187	BBCP	Plug [3/8" NPT(M)]	1

Bold print part numbers are unique to a particular pump model. Italics are optional items. [] Date of latest production change.

R Components comply with RoHS Directive. For additional technical information see www.catpumps.com/literature/tech-bulletins.

When replacing Low-Pressure Seals with Blue-Dot Seals, wick must be installed. MATERIAL CODES (Not Part of Part Number):

ABS=ABS Plastic AL=Aluminum BB=Brass BBCP=Brass/Chrome Plated CM=Chrome-Moly F=Cast Iron FCM=Forged Chrome-moly FPM=Fluorocarbon
 NBR=Medium Nitrile (Buna-N) NY=Nylon PC=Poly Carbonate POP=Polypropylene PTFE=Pure Polytetrafluoroethylene PVDF=Polyvinylidene Fluoride
 S=304SS SCP=304SS/Chrome Plated SNG=Special Blend (Buna) SS=316SS STL=Steel STCP=Steel/Chrome Plated STZP=Steel/Zinc Plated
 SZZ=304SS/Zamak ST4=Special PTFE 4 TNM=Special High Strength

EXPLODED VIEW

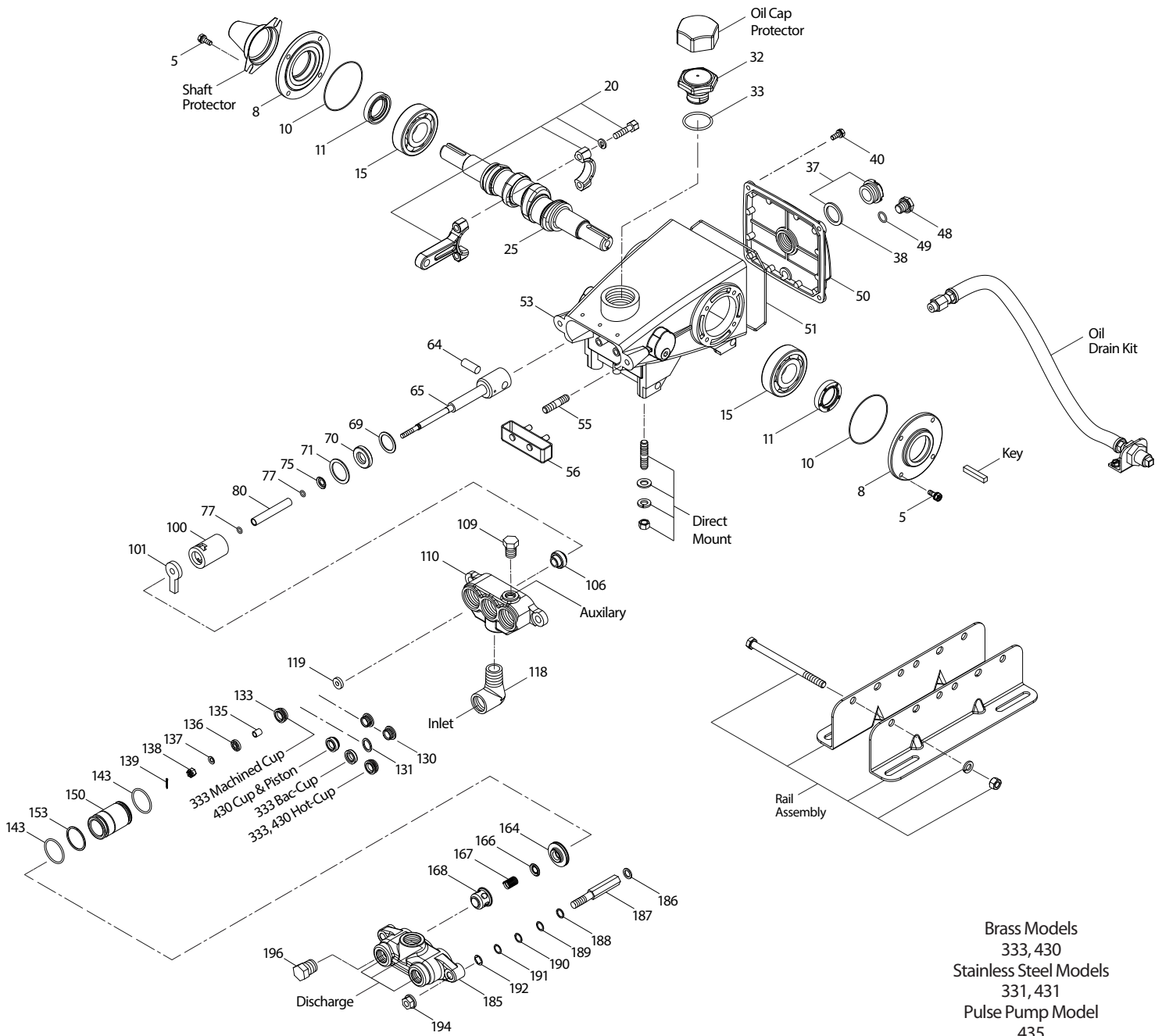

Brass Models
333, 430
Stainless Steel Models
331, 431
Pulse Pump Model
435
May 2021

OPTIONAL PARTS AND ACCESSORIES

PART	DESCRIPTION	QTY
30047	Key, M5 x 5 x 24	1
30611	Assembly, Rail	1
30652	Assembly, Mount	1
30243	Mount, Direct	1
828710	Protector, Oil Cap	1
25130	Protector, Shaft	1
34334	Kit, Oil Drain	1
30244	Pulley and Key Assembly	1
6300	Pump, Pulse (Model 435)	1

SERVICE PARTS

PART	DESCRIPTION	QTY
30305	Kit, Seal – Standard NBR	1
30686	Kit, Valve – Standard NBR	1
6107	Oil, Bottle (21 oz) ISO 68 Hydraulic (Fill to Specified Crankcase Capacity Prior to Start-up)	2
6124	Gasket, Liquid (3 oz)	1
6119	Lubricant, Anti-Seize (2 oz) (Models 331, 431)	1

SEAL KITS One (1) seal kit required per pump

PUMP MODELS	NBR (STD)	Blue Dot*		
333, 331, 430, 431, 435	30305	30229		
ITEM (Included in Seal Kits)	DESCRIPTION		QTY	
106	30315**	25153	Seal, Low-Pressure	3
139	14158	14158	Cotterpin	3
101	NA	27711	Wick	3

*Use with oil pan PN 27712

**Use PN 30325 for FPM (Ungreased)

SLEEVE AND SEAL KIT One (1) sleeve and seal kit required per pump

PUMP MODELS	NBR (STD)	Blue Dot*		
333, 331, 430, 431, 435	30312	30230		
ITEM (Included in Sleeve and Seal Kits)	DESCRIPTION		QTY	
75	25327	25327	Slinger, Barrier	3
77	25392**	25392**	O-Ring, Sleeve	6
80	25299	25299	Sleeve	3
101	NA	27711	Wick	3
106	30315***	25153	Seal, Low-Pressure	3
139	14158	14158	Cotterpin	3

*Use with oil pan PN 27712, **Use PN 28771 for FPM or PN 28772 for PTFE

***Use PN 30325 for FPM (Ungreased)

CUP KITS One (1) cup kit required per pump

Pump Models	331	331	331	331	430, 431, 435	430, 431, 435	430, 431, 435
	333	333	333	333	435	435	435
	NBR (STD)	NBR (HOT)	NBR (BAC-CUP)	TG (CUP-Piston)	NBR (STD)	NBR (HOT)	ST4 (CUP-Piston)
	30239	NSU	30841	34019*	30023	30272	76333

ITEM (Included in Cup Kits)	DESCRIPTION						QTY	
133	28955	29088	43717	76515*	43172	29089	Cup	3
139	14158		14158		14158	14158	Cotterpin	3
143	23172**		23172**		23172**	23172**	O-Ring, Cylinder	6
153	21985		21985				Backup Ring, Cylinder	3
355			43749		22130		Insertor, Cup	1

*34019 and 76515 comes with a FPM O-ring, ** Use PN 11377 for FPM or PN 703244 for PTFE

PISTON KITS One (1) piston kit required per pump

PUMP MODELS	331, 333	331, 333	430, 431, 435
	NBR (STD)	FPM (BAC-CUP)	NBR (STD)
	30240	30842	30210

ITEM (Included in Piston Kits)	DESCRIPTION			QTY	
119	28339	28339	27004	Valve, Inlet	3
130	30543	43784	27820	Piston	3
131		43719		Bac-Cup Ring	3
133	28955	43717	43172	Cup	3
135	27983	27983	27983	Spacer, Piston	3
136	27002	27002	27002	Retainer, Piston	3
137	27006	27006	27006	Washer, Conical	3
138	27000	27000	27000	Nut, Slotted	3
139	14158	14158	14158	Cotterpin	3
143	23172	23172	23172	O-Ring, Cylinder	6
153	21985	21985		Backup Ring, Cylinder	3
355			22130	Insertor, Cup	1

VALVE KITS One (1) valve kit required per pump

PUMP MODELS	NBR (QUIET)	NBR (FLAT)	NBR (PULSE)
331, 333, 430, 431	30686	30224	—
435 for Pulse Pump 6400			30103

ITEM (Included in Valve Kits)	DESCRIPTION			QTY	
143	23172	23172	23172	O-Ring, Cylinder	6
153	21985			Backup Ring, Cylinder	3
164	43434	29487	29487	Seat	3
166	43723	22842	22842	Valve	3
167	43360	22031	22031	Spring	3
168	43442	22841	22841	Retainer, Spring	3
			30497	Washer, Seal	3
			28419	Spring (Flat)	1
			26886	Retainer, Spring	1

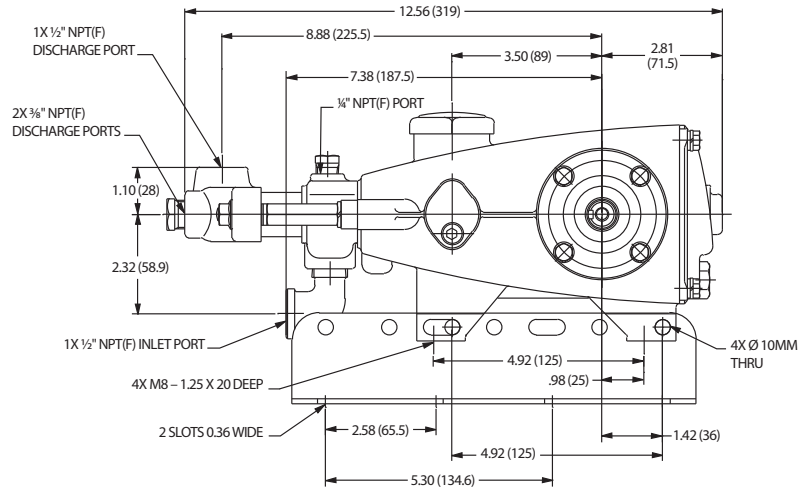
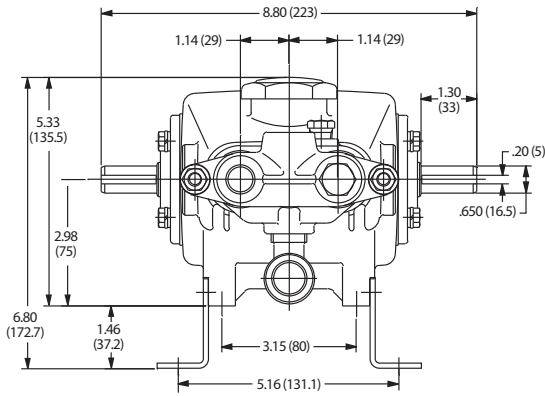

Models 333, 430

CAUTIONS AND WARNINGS

All high-pressure systems require a primary pressure regulating device (i.e. regulator, unloader) and a secondary pressure relief device (i.e. pop-off valve, relief valve). Failure to install such relief devices could result in personal injury or damage to pump or property. Cat Pumps does not assume any liability or responsibility for the operation of a customer's high-pressure system. Read all CAUTIONS and WARNINGS before commencing service or operation of any high-pressure system. The CAUTIONS and WARNINGS are included in each Service Manual and with each Accessory Data sheet. CAUTIONS and WARNINGS can also be viewed online at www.catpumps.com/dynamic-literature/cautions-and-warnings or can be requested directly from Cat Pumps.

WARRANTY

View the Limited Warranty on-line at www.catpumps.com/literature/cat-pumps-limited-warranty

CAT PUMPS 1681 94th Lane N.E., Minneapolis, MN 55449-4324 P: (763) 780-5440 F: (763) 780-2958 E: techsupport@catpumps.com www.catpumps.com

©2021 Cat Pumps Inc. All rights reserved. All data contained in this document are based on the latest product information available at the time of publication. Cat Pumps reserves the right to make changes at any time without notice.